

SONAPHONE

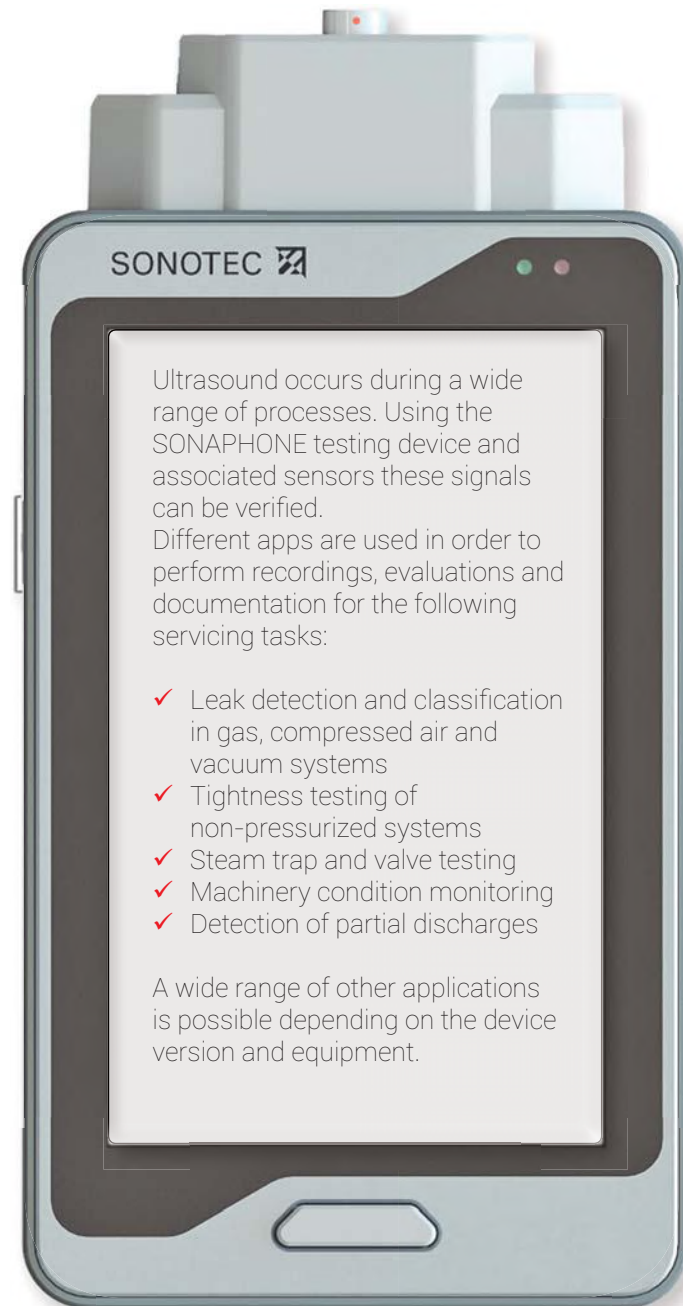

SHORT INSTRUCTIONS
ULTRASONIC TESTING DEVICE

Device Functions, Buttons and Start Screen



The short instructions set out the device functionality and explain the basic operating options. Detailed descriptions can be found in the user documentation.



Notes on your safety

Before commissioning and using the SONAPHONE and its accessories, always read all of the safety information in the user documentation.

All applicable safety regulations for industrial facilities must be complied with without fail when carrying out tests with the SONAPHONE and associated sensors.

The SONAPHONE and its accessories comply with the current state of the art and the safety-related regulations. The user must ensure that safe use is not impaired.

Do not open the device or the sensors. They do not contain any parts that need to be cleaned or maintained by the user (information on battery replacement can be found in the user documentation).

In cases of visible damage, or if malfunctions suggest that the device or sensors are no longer working properly, they must be taken out of operation immediately.

When using the waveguides, it is essential to ensure that no injuries are caused by the tips.

Connections, Interfaces and Additional Device Elements

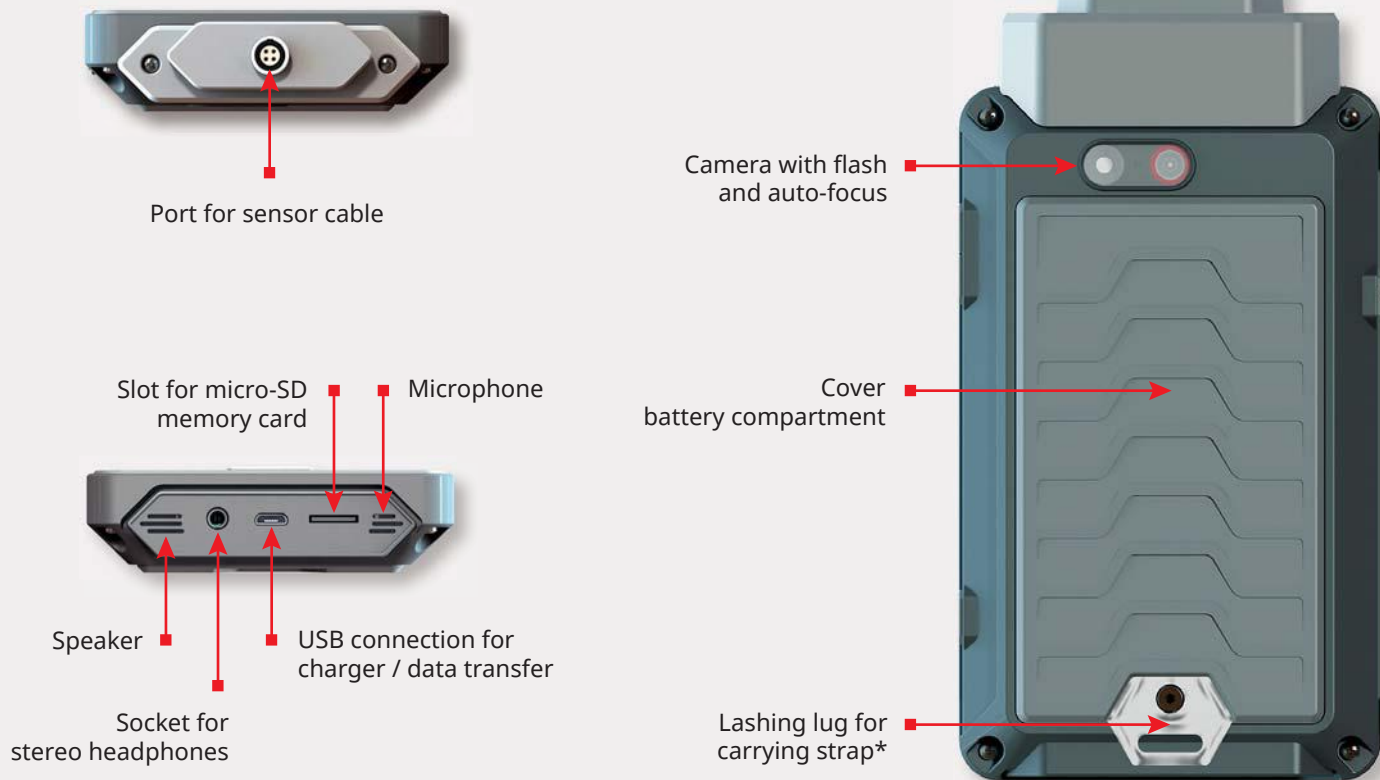

Tests with the SONAPHONE

1 Preparation

- Charge the device using the supplied charger.
- Connect the sensor to the SONAPHONE using the appropriate cable. Observe the red marking.
- If necessary, connect the headphones using the cable.



The headphones are switched on at the capsule (press and hold the button for 3 seconds until a signal is heard). The ambient noise volume can be adjusted by pressing the "+" and "-" buttons.

- Switch on the device: Press and hold the button on the left of the device until the start screen appears.

- Unlock the device: Swipe the  "unlock" icon on the display to the side.
 - ↳ The device shows the most important apps that can be opened via quick access.

Important quick-access settings:

Swipe the start screen to the side

Additional apps: Tap the  icon

2 Start the app and log in

- Select the LevelMeter app: Tap the  icon
- Enter the user name (shown via the additional data on the display) and press "Start" to confirm.

Sensor Operation

Airborne sound sensor BS10 with accessories*

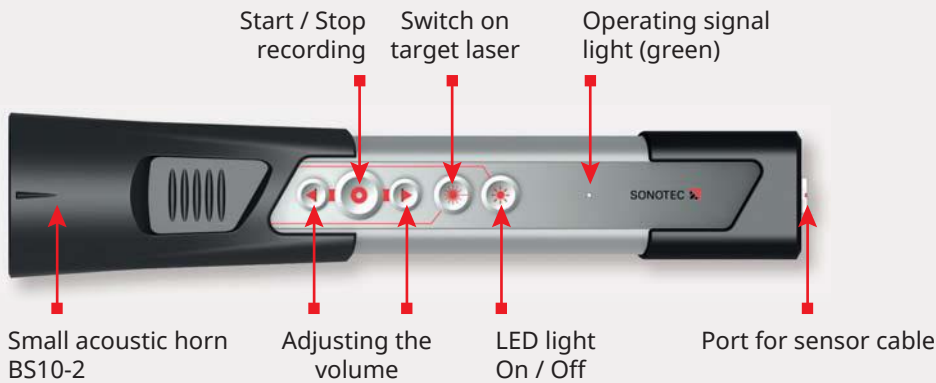

Precise locator BS10-1*



Structure-borne sound and temperature sensor BS20 with accessories*



Once the app has been started up, the test values can be read off the display (see display description on the next page). The audio output is activated at the same time.



The test data is not recorded.
To start the recording: See next page.

Top display area: Spectrogram

Switch to level record: Tap the icon in the top left-hand corner

Middle display area: Test value output

Adapt the output for up to 5 test values:
Press and hold inside the display area or tap the relevant output field once

Bottom display area:

Start / Stop measurements, manage folders

Flip screen: Tap the  icon

*Optional accessories

3

Important settings

- Select application: In the additional data area, tap the application field ("No application")
- Activate application: Select using the checkbox
- ↳ The checkbox turns green and the application automatically returns to the measurement screen



The measurements are collected in folders and assigned consecutive numbers.

- Define a name for the current folder:
Tap the  "Folder" icon and rename an existing folder or create a new folder
- Tap "OK" to confirm
- Activate a folder: Tap the checkbox (turns green)
- ↳ The application returns to the measurement screen

Display Elements and Functions of the LEVELMETER App

Testing mode

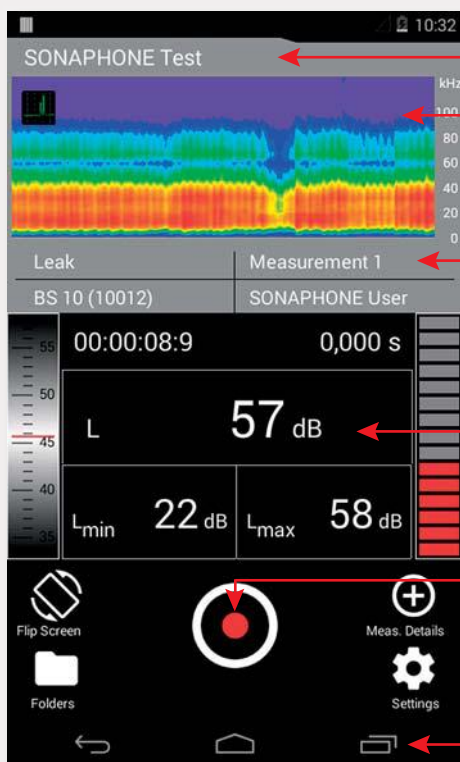

Active folder for tests

Graphical output of the test data:
Spectrogram (Fig. left)
Level record (Fig. on the right)

Additional data for the test
being carried out:

Type of application (leak),
Connected sensor (BS10),
Name of test being carried out,
User (SONAPHONE User)
Numerical output of test values
(can be adapted individually)

Playback recording

Recording: Start / Stop

Move to the previous / next
measurement

Back / Home /
Active applications (left to right)

Playback mode

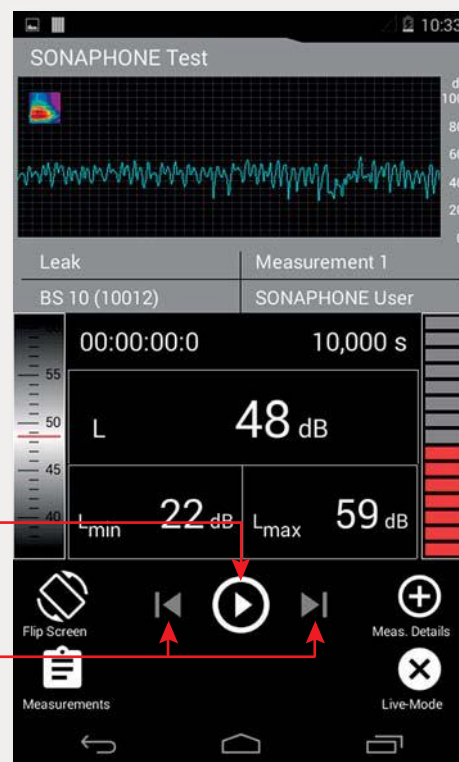

(When using other software applications, the display elements may vary from those shown).

4 Start / Stop recording

- Start: Tap the icon to start, or press the "Recording" button on the sensor.
- ↳ The icon turns red, the device records for 10 secs and then stops automatically (timings can be adjusted)
- Stop manually: Tap the icon / press the button.

- Confirm by tapping "OK" (bottom screen).
- ↳ All test data and the additional data will be stored in the defined folder.



Tapping the "Measurement Details" icon allows for test data to be quickly expanded upon to include additional information after it has been saved.

5 Complete the testing data

- Add photo / comment / voice memo: Tap the icon and add the desired content.



Note: End the text input with "✓".



6 Playback the testing data

- Select the test: Tap the "Folder" icon and select an individual measurement.
- Play back the data: Tap the icon for playback
- Add data retroactively:
Tap the icon (then proceed as per Point 5).
- Back to Live Mode: Tap the icon.

Quick Start



- 1** ✓ Load battery
✓ Connect sensor
✓ Switch on device
✓ Switch on headphones

- 2**  Tap the LevelMeter app and create a user name

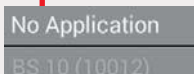
- 3**  Open the folder overview
-  Create a new folder or select an existing folder: Active folder = green background
-  Go back to testing mode
↳ The active folder is shown on the display

-  Tap the application field (additional data in the top left-hand field)



-  Activate the required application: Active application = green background
↳ The device automatically returns to Live Mode

- 4**  Start test
↳ Recording activated: The icon turns red
-  Stop the test manually

- 5**    Add a photo / comment / voice memo

Prepare test data for export

-  Open the folder overview

-   Compile data in a test report (.pdf)
Export all test data (.zip)

-  Select the required data. Tap "OK" to confirm.
↳ The data is compiled for export.

-  Go back to testing mode
↳ The data is ready for transfer.

Notes

The name will be shown on the display and in the exported data. Choose a unique name.

An active folder must be stored in order to start a test.

Folders are automatically assigned consecutive numbers. The name can be edited (tap the name). Close the keyboard with "".

The application will be shown on the display and in the exported data. It is also used for evaluation.

User-defined applications can be stored by selecting "Create new application".

The recording stops automatically after 10 seconds.

Change value: " Settings" - "Measurement settings"

For documentation purposes and for the report, each test can be expanded upon to include the elements on the side.

Areas of damage can be marked on the photos.

The test data can be compiled in the internal memory for evaluation in Data Viewer (computer software for LevelMeter app) and as a test report (.pdf).

The data can then be transferred to an end device.

The SONAPHONE operating system includes free software under license. More information can be found in the user documentation. Subject to technical modifications! Revision: 1.0; Date: 2016-09-13, Software version: LevelMeter V1.0.0